

# Exemplo de Montagem:

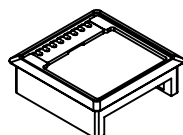

-Caixa para tomada com 3 dados e 2 elétrica.

-Codigo: DPI0004P

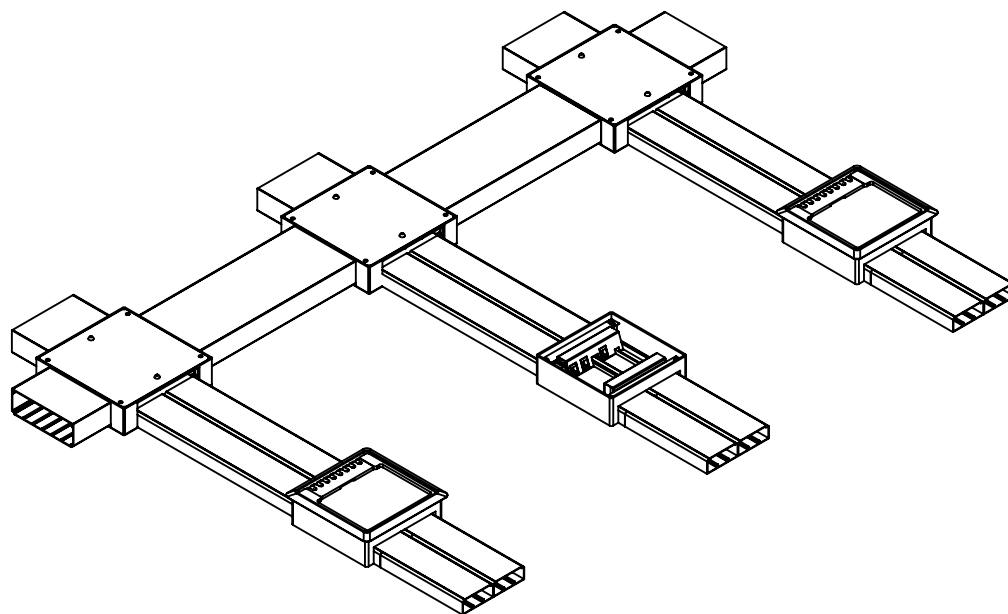
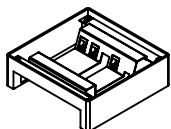

-Caixa para tomada com 3 dados e 2 elétrica.

-Codigo: DPI0004

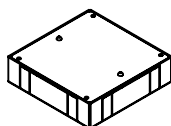

-Caixa de Derivação.

-Codigo: DPI0005

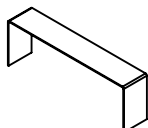

-Mata junta 150x50.

-Codigo: DPI0010

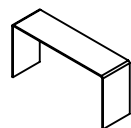

-Mata junta 100x50.

-Codigo: DPI0045

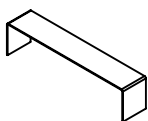

-Mata junta Duplo 70.

-Codigo: DPI0046

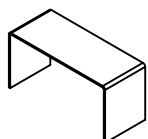

-Mata junta 70.

-Codigo: DPI0047

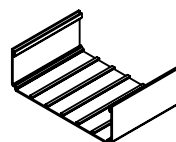

-Eletrocalha 150x50.

-Codigo: ELT0X04

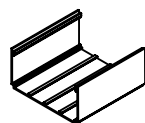

-Eletrocalha 100x50.

-Codigo: ELT0X02

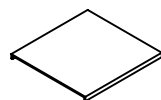

-Tampa do Duto 150x50.

-Codigo: ELT0X03

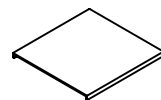

-Tampa do Duto 100x50.

-Codigo: ELT0X01

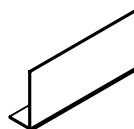

-Divisor.

-Codigo: ELT0X05

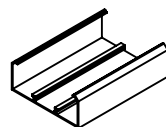

-Duto 70x35.

-Codigo: ECB0104

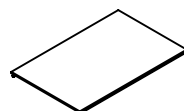

-Tampa Duto 70x35.

-Codigo: CET0104

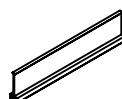

-Divisor Duto 70x35

-Codigo: ECD0001